

WIPCOOL[®]
IDEAL PRODUCTS FOR HVAC

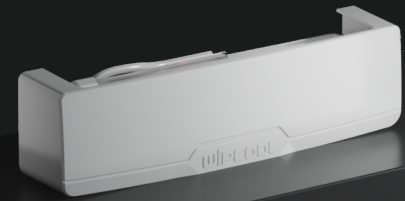

CONDENSATE PUMP

P20/38

- Operation Manual -



 YouTube www.wipcool.com
Scan us for more details

1. Explosion Diagram

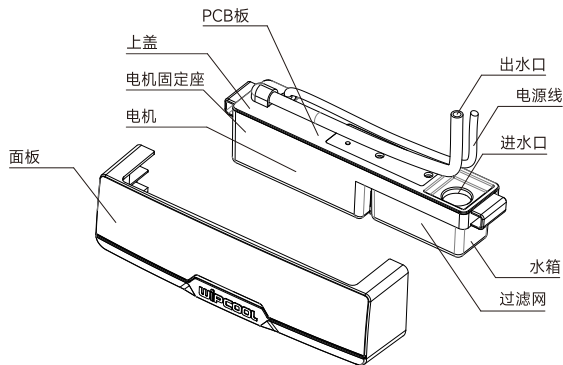

2. Dimension

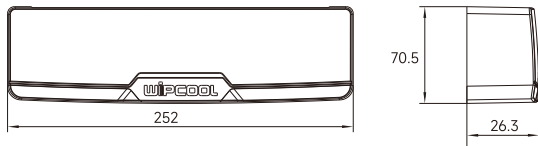

3. Technical Data

Model	P20	P38
voltage	100-230V~/50-60Hz	
Discharge head(Max.)	10m(33ft)	
Flow rate(Max.)	20L/h(5.3GPH)	38L/h(10GPH)
Tank capacity	80ml	
Mini splits up to	30,000btu/hr	45,000btu/hr
Sound level at 1m	19dB(A)	21dB(A)
Ambient temp.	0°C ~ 50°C	

4. Flow Rate Chart

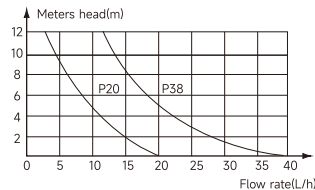

Model	Performance(l/h@head)					
	0m	2m	4m	6m	8m	10m
P20	20	15	12	8	6	4
P38	38	27	23	17	15	13

5. Safety Instructions

- 5.1. Place the tank horizontal when installing, do not tilt the pump. Check whether the level drop is centered; if there is tilt, adjust the water level before using it.
- 5.2. Do not place electrical appliances or valuables under the condensate pump to avoid loss caused by power failure or water leakage.
- 5.3. Non - professional personnel should not install it to avoid danger.
- 5.4. The condensate pump is not waterproof. Do not place it in the open air, outdoors or in a place prone to flooding.
- 5.5. The condensate pump power supply needs to be independent to maintain permanent power supply. For details of connecting with air conditioning system, please refer to the wiring diagram.

-  5.6. It is prohibited that the water inflow is bigger than our stated flow rate, which will easily cause the motor to work continuously and fail. Instant big water inflow will also cause the condensate pump fail to discharge water in time, leading to water leakage.

6. Installation Procedure

- (1) Cut off the power
- (2) Select location at the lower left or right* of the air conditioner.

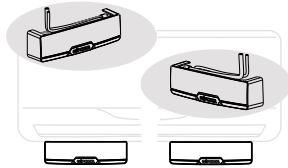

- (3) Mark and make holes in the wall according to the location for installation

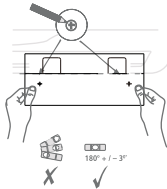

- (4) Make holes in the wall according to the location for installation and then fix the pump with bolts and anchors.

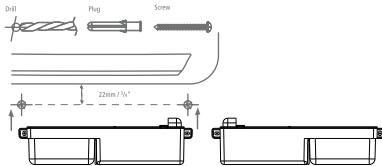

- (5) Insert the air conditioner drain hose all the way into the reservoir and connect the pump's discharge hose to the external drain hose. (At this time, be careful that the air conditioner drain hose does not interfere with the water level sensor inside the product water container.)
 - Hose standard: 6mm or 1/4" (inner diameter) x 9mm or 3/8" (outer diameter)
 - Be careful not to kink or pinch off the hose if bending.
 - Pump comes with a red 1/4" hose mender pre-installed in the discharge hose.

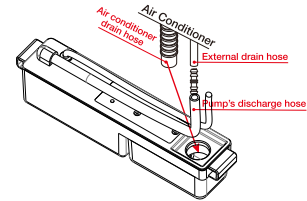

- (6) Ensure that power is shut off to the air conditioning unit. Connect the power cable of the pump to the respective power terminals. Power should be continuously supplied to this equipment except when maintenance or follow-up service is carried out.

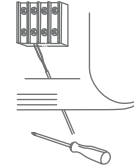

Test the pump after installation:

Pour a little water into the drain pan of the air conditioner's indoor unit. When the water level increases to about 21mm [83 in], the pump should turn on for 3 seconds or less, discharging the water, and then turn off. Repeat this step 8-10 times. Check any leakage of water or generation of abnormal noise while the pump runs. Though there may be a loud noise in the first 1-2 operations until the entering air escapes and the pump is primed, this is not a failure.

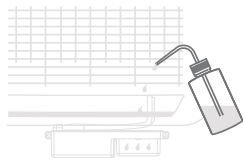

(7) After installation is complete, install the cover according to the rubber parts.

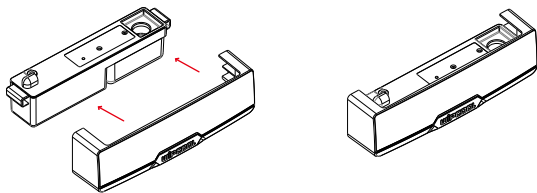

7. Maintenance

1. Be sure to maintain the equipment in the following order when you stop operation of the air conditioner after summer season or resume operation of the air conditioner in early summer.
2. Be sure to cut off the power supply before maintaining this equipment
3. Remove the cover. Remove the reservoir by pushing the hook like tab closest to the edge of the pump (have a towel prepared in case some water spills out). Detach the hose at the outlet of the reservoir. Keep the spring inside of the hose.

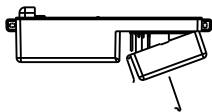

4. Wash the inside of the reservoir with water and mild soap. Wash the filter screen to remove any built up residue or debris.

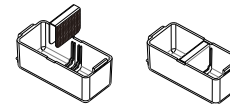

5. Push the outlet of the reservoir onto the hose. Snap the reservoir back into place by aligning the tabs with the slots.
6. Supply power to this equipment again and test the pump according to Step 7 in How to Install The Product.

8. Troubleshooting

Problem	Cause	Action
Pump runs all the time	1. Installation is not horizontal	Adjust the tank make it level
	2. There is sludge inside tank	Clean the inside of tank and probe surface
Pump makes loud noise	1. The water is siphoning back in the pump	Check whether the outlet pipe is lower than pump thus result in siphoning, raise the condensate pump position
Pump can't start working	1. Installation is not horizontal	1. Adjust the tank, check water level
	2. The power can't reach pump	2. Check power supply
	3. The voltage isn't correct	3. Check the voltage

Note: Proper use and maintenance can improve the life of pump. We suggest to check and clean the condensate pump before seasons changing or next year using.